

AOS Technology Ltd
14 Pate Road
Melton Mowbray
Leicestershire, LE13 0RG
United Kingdom
Tel: (44) 1664 567711
Fax: (44) 1664 567712
www.aosproducts.com

SPECIFICATIONS

Ultra Narrow Linewidth 1665nm Laser In BTF Package

DL-CLS051B-S1665

DenseLight Semiconductors reserves the right to make product design or specifications changes without notice.

A. PRODUCT DESCRIPTION

DenseLight DL-CLS051B-S1665 is a cooled ultra narrow linewidth laser in BTF package with SMF pigtail emitting at 1665nm wavelength. It is engineered for modulation up to 622Mbps. This laser is based on an external cavity laser with built-in fiber Bragg grating, offering very stable performance of lasing wavelength, narrow spectral linewidth and excellent SMSR.

B. FEATURES

- Strained InGaAsP/InP MQW gain chip coupled with built-in fiber Bragg grating
- Lasing wavelength of 1665nm
- Minimum 5mW CW operation
- Minimum SMSR of 35dB
- Typical linewidth of 5kHz
- Internal thermoelectric cooler and thermistor
- Designed for 155/622Mbps operation
- RoHS Compliance

C. PACKAGING

- 14-pin BTF package with SMF-28 pigtail

D. APPLICATIONS

- OTDR
- Optical measuring instrumentation
- Optical gas and chemical sensor

E. ABSOLUTE MAXIMUM RATINGS

Parameter	Symbol	Condition	Min	Max	Unit
Reverse voltage	V_R			2	V
Forward current	I_F			120	mA
Forward voltage	V_F	I_{op}		2.5	V
Case temperature	T_c	I_{op}	0	60	°C
Laser temperature ¹	T_{Laser}	I_{op}	0	70	°C
Thermoelectric cooler voltage	V_{TEC}			3.0	V
Thermoelectric cooler current	I_{TEC}			1.8	A
Storage temperature	T_{stg}	Unbiased	-40	85	°C
Storage humidity			5	85	%RH
Electro static discharge (ESD)	V_{ESD}	Human body model		500	V
Lead soldering temperature	S_{temp}			260	°C
Lead soldering time	S_{time}			10	sec

F. ELECTRICAL AND OPTICAL CHARACTERISTICS

($T_{Laser} = 25\text{ °C}$, unless otherwise noted)

Parameter	Symbol	Test Conditions	Min	Typ	Max	Unit
Optical output power	P_O	CW	2	–	–	mW
Threshold current	I_{th}	CW	–	25	35	mA
Operating current	I_{op}	CW, 5mW	–	–	70	mA
Operation voltage	V_{op}	CW, 5mW	–	1.5	2.0	V
Slope efficiency	η	CW, 5mW	0.05	0.1	–	mW/mA
Peak wavelength	λ_p	CW, 5mW	1663	1665	1667	nm
Side mode suppression ratio	SMSR	CW, 5mW	35	–	–	dB
Linewidth	$\Delta\lambda$	CW, 5mW	–	–	50	kHz
Thermistor resistance	R_{therm}	$T_{therm} = 25\text{ °C}$	9.5	10	10.5	k Ω

¹ T_{Laser} is monitored by internal thermistor with external pin out.

G. PACKAGE

Part	Description
Package type	14-pin BTF
Fiber:	SMF-28
MFD	9μm
Cladding diameter	125μm
Coating diameter	245μm
Fiber pigtail length	>1m
Fiber connector	FC/APC

H. OUTLINE DRAWINGS

Typical Package Dimension

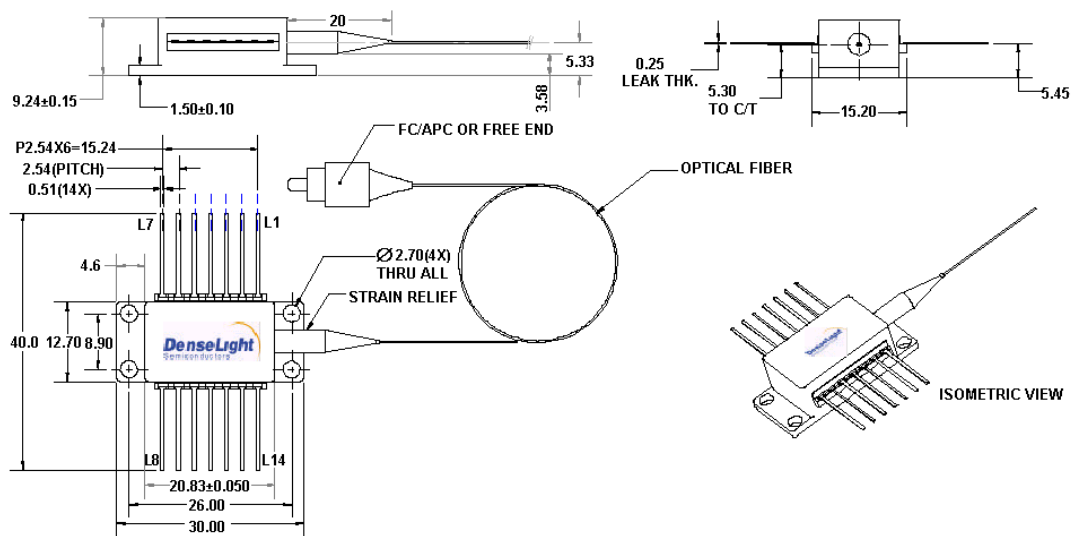

Pin Assignment	
1	TEC (+)
2	THERMISTOR
3	
4	
5	THERMISTOR
6	-
7	-
8	-
9	-
10	LD ANODE (+)
11	LD CATHODE (-)
12	-
13	CASE
14	TEC (-)

